













|   |  |        |             |                |      |
|---|--|--------|-------------|----------------|------|
| Dokumentnamn: Reservdelslista belysning |  |        |             | Rev 2025-02-11 |      |
| Framtagen av:                           | Fastställd av:                               | Utgåva | Gäller från | Område         | Sida |
| Rasmus Robertsson<br>PLs                | Roberto Montero<br>KMA Koordinator PLS Group | 1      | 2024-11-27  | 8.2            | 1    |

# Reservdelslista samling (belysning)

| Artikel nr.      | Artikelnamn   | Beskrivning   |  |
|------------------|---|---------------|--|
| <b>528274.06</b> | Takbelysning infälld 6-LED  | ("gamla")     |  |
|                  |    |               | <i>Används i kombination med tryckknapp</i>                  |
| <b>528798</b>    | Innerbelysning LED rörelsesensor PIR  | (med sensor)  |  |
|                  |    |               | <i>Monteras som std.<br/>2st vid ÖBS och<br/>1st vid FAS</i> |
| <b>528799</b>    | Innerbelysning LED  | (utan sensor) |  |
|                  |   |               | <i>Monteras tillsammans med<br/>528798</i>                   |
| <b>528797</b>    | Innerbelysning LED 12/24V   |               |  |
|                  |  |               | <i>Vid belysning på överlucka</i>                            |
| <b>528293</b>    | MS6 LED Blixtljus   |               |  |
|                  |  |               | E-godkänd R65  |
| <b>528254.E</b>  | Backlampa LED E-godkänd   |               |  |
|                  |  |               |  |

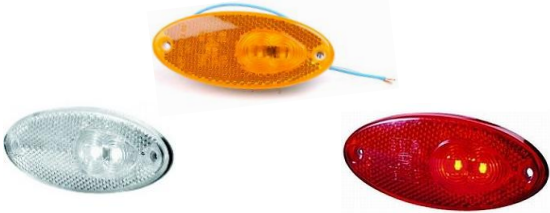
|                  |   |   |                                 |
|------------------|---|---|---------------------------------|
| <b>528333</b>    | ARBETSBELYSNING AVLÅNG 40W LED  |   |                                 |
|                  |    |   |                                 |
| <b>528337</b>    | BACKLJUS LWL-01   |   |                                 |
|                  |    |   |                                 |
| <b>528285</b>    | Vit positions ljus, diod  | Oval  |                                 |
| <b>528286</b>    | Röd positions ljus, diod  | Oval  |                                 |
|                  |  | <b>528315</b><br>Packning<br>pos.ljus<br>snigel | <i>Positionsljus typ snigel</i> |
| <b>528287</b>    | Vit positions ljus, diod  | Rektangulärt                                    |                                 |
| <b>528660</b>    | Rött positions ljus, diod   | Rektangulärt                                    |                                 |
|                  |  |   |                                 |
| <b>528667.01</b> | Vit positions ljus, diod  | ellips  |                                 |
| <b>528667.02</b> | Orange positions, diod  | ellips  |                                 |
| <b>528667.03</b> | Röd positions ljus, diod  | ellips  |                                 |
|                  |  |   |                                 |

|                  |   |   |   |
|------------------|---|---|---|
| <b>528741</b>    | POSLJUS LED 12-24 V   | (Thomas-lampa)                              |   |
|                  |    |   |   |
| <b>800323</b>    | Fiberoptisk bak/broms/blinkers  |   |   |
|                  |    | <b>528315.31</b><br>Packning<br>fiberoptisk | <i>Baklampa med tre<br/>funktioner, bakljus,<br/>bromsljus och blinker</i>          |
| <b>528697</b>    | Gul Sidomarkering, diod   | kort gummiarm                               |   |
|                  |   |   |   |
| <b>528675</b>    | Sidomarkljus kort arm LED   |   |   |
|                  |  |   | <i>Gummiarm med<br/>sidomarkeringsljus i LED<br/>med vitt, rött och orange ljus</i> |
| <b>528324</b>    | Sidomarkering, diod   | kort  |   |
| <b>528325</b>    | Sidomarkering, diod   | Lång  |   |
|                  |  |   |   |
| <b>528695</b>    | Led-modul orange-orange   |   |   |
| <b>528695.40</b> | Lång gummiarm   |   |   |
| <b>528695.42</b> | Kort arm  |   |   |
|                  |  |   |   |

|                  |   |  |  |
|------------------|---|--|--|
| <b>528249.20</b> | Skyltbelysning LED 24V  |  |  |
|                  |  |  |  |

|               |   |  |  |
|---------------|---|--|--|
| <b>970100</b> | LAMPHÅLLARE ALUM  |  |  |
| <b>800025</b> | HÅLLARE NUMMERPLÅT  |  |  |
| <b>800012</b> | FÄSTPLÅT MANÖVERDON 3+1   |  |  |
|               |  |  |  |

|               |   |  |  |
|---------------|---|--|--|
| <b>800341</b> | Strands Positionsljus Röd slim 3 LED,9-36V IP68. E-märkt.                           | RÖD  |  |
|               |  | <b>528315.21</b><br>Packning<br>pos.ljus<br>slim |  |

|               |   |  |  |
|---------------|---|--|--|
| <b>800342</b> | Strands Positionsljus Vit slim 3 LED,9-36V IP68. E-märkt.                           | VIT  |  |
|               |  | <b>528315.21</b><br>Packning<br>pos.ljus<br>slim |  |

|               |   |  |  |
|---------------|---|--|--|
| <b>626040</b> | GRÄNSLÄGESBRYTARE   |  |  |
|               |  |  |  |

|               |   |                     |  |
|---------------|---|---------------------|--|
| <b>528336</b> | LED POSITIONSLAMPA GYD LÅNG ARM<br>RÖTT/ORANGE                                    | LÅNG,<br>RÖD/ORANGE |  |
|               |  |                     |  |

|               |   |               |  |
|---------------|---|---------------|--|
| <b>528324</b> | POSITIONSLAMPA VIT/RÖD KORT   | KORT, VIT/RÖD |  |
|               |  |               |  |

|               |   |               |  |
|---------------|---|---------------|--|
| <b>528325</b> | POSITIONSLAMPA VIT/RÖD LÅNG   | LÅNG, VIT/RÖD |  |
|               |  |               |  |

|                 |   |                     |  |
|-----------------|---|---------------------|--|
| <b>528335.1</b> | LED SIDOMARKERINGSLAMPA GYD KORT<br>ARM ORANGE/ORANGE                               | KORT,<br>ORANGE x 2 |  |
|                 |  |                     |  |

|                  |   |                     |  |
|------------------|---|---------------------|--|
| <b>528335.11</b> | LED POSITIONSLAMPA GYD KORT ARM<br>RÖTT/ORANGE                                      | KORT,<br>RÖD/ORANGE |  |
|                  |  |                     |  |

|               |   |        |  |
|---------------|---|--------|--|
| <b>800320</b> | FIBEROPTISK SIDOMARKERINGSLJUS<br>ORANGE  | ORANGE |  |
|               |  |        |  |

|               |   |     |  |
|---------------|---|-----|--|
| <b>800321</b> | FIBEROPTISK POSITIONSLJUS RÖD   | RÖD |  |
|               |  |     |  |

|               |   |     |  |
|---------------|---|-----|--|
| <b>800322</b> | FIBEROPTISK POSITIONSLJUS VIT   | VIT |  |
|               |  |     |  |

|               |   |  |  |
|---------------|---|--|--|
| <b>800349</b> | GUMMIPACKNING BAK/BROMS/BLINKERS  |  |  |
|               |  |  |  |

|               |   |  |  |
|---------------|---|--|--|
| <b>528315</b> | PACKNING POSLJUS OVAL (SNIGEL)  |  |  |
|               |  |  |  |

|                  |   |  |  |
|------------------|---|--|--|
| <b>528315.21</b> | PACKNING STRANDS POSITIONS LJUS SLIM  |  |  |
|                  |  |  |  |

|                  |   |  |  |
|------------------|---|--|--|
| <b>528315.31</b> | PACKNING FIBEROPTISK POS LJUS   |  |  |
|                  |  |  |  |

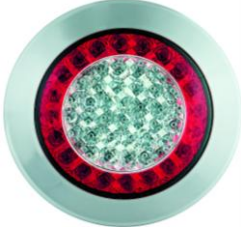
|               |   |  |  |
|---------------|---|--|--|
| <b>528740</b> | BAKLAMPA JOKON LED, RUND  |  |  |
|               |  |  |  |

|                  |   |  |  |
|------------------|---|--|--|
| <b>528740.03</b> | BAKLAMPA JOKON LED, DIMBAKLJUS  |  |  |
|                  |  |  |  |

|                  |   |  |  |
|------------------|---|--|--|
| <b>528740.04</b> | BAKLAMPA JOKON LED, BACKLAMPA   |  |  |
|                  |  |  |  |

|                  |   |  |  |
|------------------|---|--|--|
| <b>528740.07</b> | BAKLAMPA JOKON LED, BAK-BROMS   |  |  |
|                  |  |  |  |

|                  |   |  |  |
|------------------|---|--|--|
| <b>528740.09</b> | BAKLAMPA JOKON LED, DIM&BACK  |  |  |
|                  |  |  |  |











|  |   |     |  |
|--|---|-----|--|
| <b>ASPÖCKS art.nr</b>                        | ASPÖCK ECOLED II (BIL)  |     |  |
| 25-4121-067 (Vänster)<br>25-4120-067 (Höger) |  | BIL |  |



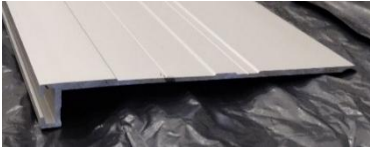

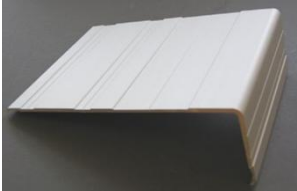
|  |   |      |  |
|--|---|------|--|
| <b>ASPÖCKS art.nr</b>                        | ASPÖCK ECOLED II (SLÄP)   |      |  |
| 25-4121-047 (Vänster)<br>25-4120-047 (Höger) |  | SLÄP |  |



|  |  |        |             |        |                |  |
|--|--|--------|-------------|--------|----------------|--|
| Dokumentnamn: Reservdelslista Aluminium profiler |  |        |             |        | Rev 2025-01-24 |  |
| Framtagen av:                                    | Fastställd av:                               | Utgåva | Gäller från | Område | Sida           |  |
| Rasmus Robertsson<br>Pls                         | Roberto Montero<br>KMA Koordinator PLS Group | 1      | 2022-01-03  | 8.2    | 1              |  |

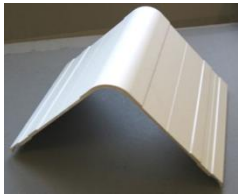

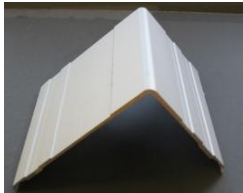
# Reservdelslista samling (Aluminium profiler)

| Art. Nr.          | Benämning:  | Mått:  | Längd:   |
|-------------------|---|--|--|
| <b>105012.260</b> | Bakstamsprofil Lucka  | inv. 167x55  | 2600mm   |
| <b>105012.380</b> | Bakstamsprofil Lucka  | inv. 167x55  | 3800mm   |
|                   |    | <b>633016</b><br>Gummilist<br>Fläbb<br>   | Används till höger bakstolpe ÖBS lucka bak, samt vänster stolpe FAS  |
| <b>105018.300</b> | Bakstamsprofil, mindre  | inv. 115x55  | 3000mm   |
| <b>105018.380</b> | Bakstamsprofil, mindre  | inv. 115x55  | 3800mm   |
|                   |    | <b>633016</b><br>Gummilist<br>Fläbb<br>   | Används till vänster bakstolpe ÖBS lucka bak, samt höger stolpe T90  |
| <b>105053.260</b> | Bakstamsprofil övre   | inv. 167x18  | 2600mm   |
|                   |   | <b>633016</b><br>Gummilist<br>Fläbb<br> | Används vid 50 tak lucka bak   |
| <b>105027</b>     | Bakstamsprofil, Dörr  | utv. 180x58  | 3800mm   |
|                   |  |  | Används till höger bakstolpe ÖBS dörrar bak, samt vänster stolpe FAS |
| <b>105027.01</b>  | Bakstamsprofil, Dörr  | utv. 118x58  | 3800mm   |
|                   |  |  | Används till vänster bakstolpe ÖBS dörrar bak, samt höger stolpe T90 |
| <b>105015</b>     | Regnlist överlucka  |  | 2540mm   |
|                   |  | <b>633020.10</b><br>Gummilist<br>       |  |

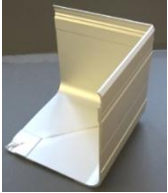
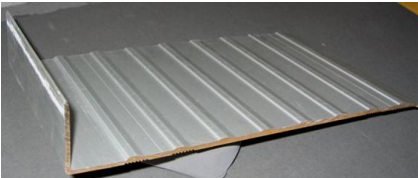
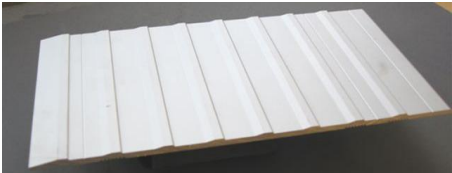
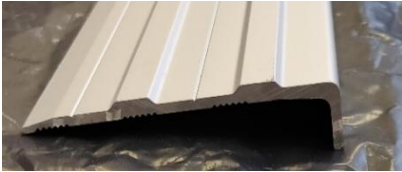
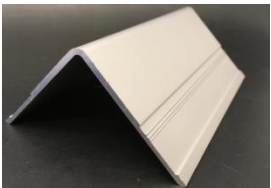
| Art. Nr.          | Benämning:  | Mått:        | Längd:  |
|-------------------|---|--------------|---|
| <b>105033</b>     | Aluminium vinkel  | utv. 85x85   | 7500mm  |
|                   |    |              | <i>Används utvändigt<br/>längdsgående T90</i>                                     |
| <b>105040</b>     | Hörnvinkel, rundad  | utv. 125x125 | 3500mm  |
|                   |    |              | <i>Används till höger<br/>framhörn<br/>samt vänster FAS</i>                       |
| <b>105040.01</b>  | Hörnvinkel, rundad  | utv. 125x61  | 3600mm  |
|                   |   |              | <i>Används till vänster<br/>framstolpe ÖBS</i>                                    |
| <b>105041</b>     | Hörnvinkel  | utv. 125x85  | 7600mm  |
|                   |  |              | <i>Används utvändigt<br/>längdsgående<br/>höger sida<br/>samt vänster FAS</i>     |
| <b>105049</b>     | HÖRNVINKEL  | utv. 168x85  | 6800mm  |
| <b>105049.260</b> | HÖRNVINKEL  | utv. 168x85  | 2600mm  |
|                   |  |              | <i>Används utvändigt<br/>längsgående släp<br/>höger sida<br/>samt vänster FAS</i> |
| <b>105042</b>     | Framstamslist 125   |              | 2348mm  |
|                   |  |              | <i>Nedre framstamslist</i>  |

| Art. Nr.          | Benämning:  | Mått:        | Längd:                                 |
|-------------------|---|--------------|--|
| <b>105043</b>     | Framstamsvinkel med hörn  | utv. 125x125 | 2600mm                                 |
|                   |    |              | ÖBS samt FAS                           |
| <b>105044</b>     | Framstamshörn utan ben  |              |  |
|                   |    |              | FAS                                    |
| <b>105020</b>     | Sparklist med fot   | 250x40       | 7500mm                                 |
|                   |   |              |  |
| <b>105021</b>     | Sparklist utan fot 250 mm   |              | 7500mm                                 |
| <b>105021.376</b> | Sparklist utan fot 250 mm   |              | 3760mm                                 |
|                   |  |              |  |
| <b>105050</b>     | Sparklist LS ALUM   |              | 7400mm                                 |
|                   |  |              | Används vid lastsäkring LS i högervägg |
| <b>105003</b>     | Vinkelprofil  | utv. 60x60   | 7500mm                                 |
|                   |  |              | Invändig vinkel                        |

| Art. Nr.      | Benämning:  | Mått:  | Längd:                         |
|---------------|---|--|--------------------------------|
| <b>103184</b> | BANDILIST 2002  |  | 2600mm                         |
|               |    |  |                                |
| <b>105010</b> | Takkantprofil ÖBS 30  |  | 7900mm                         |
|               |    | <b>103213</b><br>Gummilist<br>hoppbock<br>   |                                |
| <b>105023</b> | Takprofil ÖBS P40   |  | 7800mm                         |
|               |   | <b>103213</b><br>Gummilist<br>hoppbock<br> |                                |
| <b>105037</b> | TAKKANTPROFIL SLÄP 30   |  | 6800mm                         |
|               |  | <b>103213</b><br>Gummilist<br>hoppbock<br> |                                |
| <b>103017</b> | KANTSKONING U 30MM  |  | 6000mm                         |
|               |  |  | <i>Används till sidohinder</i> |
| <b>105007</b> | ALUVINKEL   | 6x28   | 3500mm                         |
|               |  |  | <i>Laminatsäkring ÖBS</i>      |

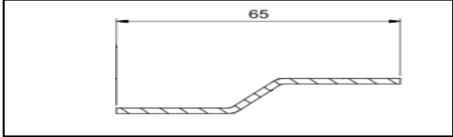
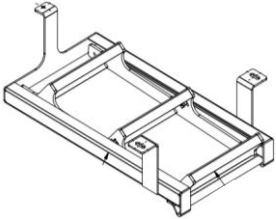
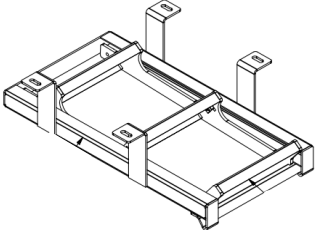

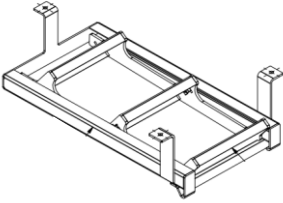
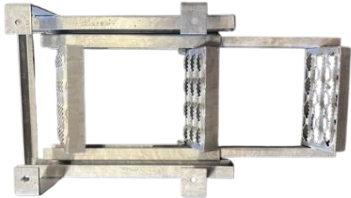
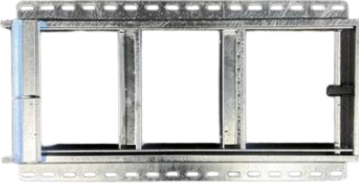



| Art. Nr.      | Benämning:  | Mått: | Längd:                             |
|---------------|---|-------|------------------------------------|
| <b>105063</b> | ALUVINKEL   | 6x37  | 3600mm                             |
|               |    |       | <i>Laminatsäkring ÖBS</i>          |
| <b>105051</b> | Framstamsprofil R80   |       | 3500mm                             |
|               |    |       | <i>Framstamsprofil<br/>Special</i> |
| <b>105066</b> | ALUVINKEL UNGL  |       | 3700mm                             |
|               |   |       | <i>Nedre vinkel<br/>sidodörrar</i> |
| <b>103231</b> | WATERSTOPP ALU  |       | 2595mm                             |
|               |  |       | <i>BAKDÖRRAR<br/>50 Tak</i>        |
| <b>820162</b> | UTDRAGBAR STEGE PLS   |       |                                    |
|               |  |       |                                    |
| <b>820168</b> | UTDRAGBAR STEGE PLS<br>TILL SLÄPVAGN  |       |                                    |
|               |  |       |                                    |









| Art. Nr.   | Benämning:           | Mått: | Längd: |
|--|----------------------|-------|--------|
| <b>717028</b>  | UTDRAGBAR STEGE PLS  |       |        |
|   |                      |       |        |
| <b>717029</b>  | STEGE UTDRAGBAR 3-ST |       |        |
|   |                      |       |        |
| <b>721023</b>  | UTDRAGBAR STEGE LÅG  |       |        |
|  |                      |       |        |
|  |                      |       |        |
|  |                      |       |        |

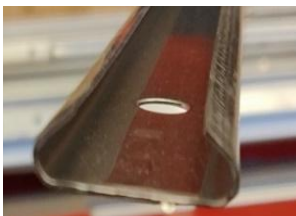

|   |  |        |             |                |      |
|---|--|--------|-------------|----------------|------|
| Dokumentnamn: Reservdelslista Gummilister |  |        |             | Rev 2025-01-24 |      |
| Framtagen av:                             | Fastställd av:                               | Utgåva | Gäller från | Område         | Sida |
| Rasmus Robertsson<br>Pls                  | Roberto Montero<br>KMA Koordinator PLS Group | 1      | 2022-01-05  | 8.2            | 1    |

# Reservdelslista samling (Gummilister)









| Art. Nr.         | Benämning:  | Mått: | Längd:   |
|------------------|---|-------|--|
| <b>103102</b>    | Gummilist sidodörrar  |       | 4150mm   |
|                  |    |       | <i>Används till sidodörrar<br/>övre gummilist</i>          |
| <b>103102.02</b> | Gummilist dörrmöte ÖBS  |       | 3600mm   |
|                  |    |       | <i>Används till sidodörrar<br/>Dörrmöte</i>                |
| <b>103103.02</b> | Gummilist P30 överlucka   |       | 3200mm   |
|                  |   |       | <i>Används till överlucka<br/>och enkeldörr</i>            |
| <b>103104</b>    | Gummilist P40 bakdörr   |       | 3600mm   |
|                  |  |       |  |
| <b>103215</b>    | Vulkgummi för hörn  | 90x20 |  |
|                  |  |       | <i>Används som förstärkning i<br/>skarvar på gummilist</i> |
| <b>103213</b>    | Gummilist "hoppbock"  |       |  |
|                  |  |       | <i>Övre längsgående<br/>gummilist ÖBS</i>                  |

| Art. Nr.  | Benämning:  | Mått: | Längd:   |
|---|---|-------|--|
| <b>103209.20</b>  | Gummilist nedre ÖBS-LS  |       |  |
| <b>868615.250</b>   | Fästskena RFS   |       | 2500mm   |
|    |    |       | <i>Nedre längsgående gummilist ÖBS</i>   |
| <b>633016</b>   | Gummilist fläbb   |       |  |
|    |    |       | <i>Avvisarlist bak stående samt uppe vid lift och lucka, ändast uppe vid bakdörrar</i> |
| <b>633020</b>   | Sidotättningslist 634   |       |  |
| <b>633021</b>   | Fästskena alu   |       | 2600mm   |
|  |  |       | <i>Stående tättningslist liftbrygga</i>  |
| <b>633020.10</b>  | Gummilist överlucka   |       | 2600mm   |
|  |  |       | <i>Nedre gummilist överlucka</i>   |
| <b>633085</b>   | Gummilist flakkant  |       | 2600mm   |
| <b>633086</b>   | Fästskena till flakkant   |       | 2600mm   |
|  |  |       | <i>Nedre tättningslist ZEPRO liftbrygga</i>  |







|                                      |  |        |             |                |      |
|--------------------------------------|--|--------|-------------|----------------|------|
| Dokumentnamn: Reservdelslista Övrigt |  |        |             | Rev 2025-02-20 |      |
| Framtagen av:                        | Fastställd av:                               | Utgåva | Gäller från | Område         | Sida |
| Rasmus Robertsson<br>PLS             | Roberto Montero<br>KMA Koordinator PLS Group | 1      | 2022-01-05  | 8.2            | 1    |

# Reservdelslista samling (Lastsäkringar)

| Art. Nr.  | Benämning:           |               |  |
|---|----------------------|---------------|--|
| <b>715194</b>   | LS handspännare      | <b>4-Pack</b> | 50mm   |
|    |                      |               | Levereras med 0,3m band<br>samt öglebeslag 815532.10<br>Till LS skena ÖBS<br> |
| <b>715195</b>   | LS Band 10m          | <b>4-Pack</b> | 50mm   |
|    |                      |               | För montering i<br>lastsäkrings sockel<br>(Citronskena) i vägg<br>            |
| <b>815532.10</b>  | Öglebeslag LS        |               |  |
|   |                      |               | För montering i ÖBS kantlina<br>  |
| <b>715193</b>   | LS-Band med ögla 10m |               | 50mm   |
|  |                      |               | Kombineras med<br>öglebeslag 815532.10   |
| <b>715196.50</b>  | Handspännare ERGO    |               | 50mm   |
|  |                      |               | Omvänd spänn manöver<br>Levereras med 0,5m band<br><br>kompletteras med öglebeslag<br>815532.10  |
| <b>815555</b>   | LS-adapter 63 MM     |               |  |
|  |                      |               | Monteras i 63mm LS<br>stakhylsa för surring med<br>815532.10 Öglebeslag  |

|   |                          |  |   |
|---|--------------------------|--|---|
| <b>815538</b>   | Ringbeslag               |  |   |
|    |                          |  | <p>För montering i lastsäkrings sockel (Citronskena) i vägg</p>  |
| <b>815538.50</b>  | Ringbeslag med krokfäste |  |   |
|    |                          |  | <p>För montering i lastsäkrings sockel (Citronskena) i vägg</p>  |
| <b>714998.20</b>  | Minispännare ÖBS         |  |   |
|   |                          |  | <p>Tillbehör:<br/>715210 Spärnnyckel</p>                       |
| <b>103184</b>   | Bandilist 2600mm         |  |   |
|  |                          |  |   |
| <b>715121</b>   | Bandi Bandspade          |  |   |
| <b>868795</b>   | Blad till LS-Spade       |  |   |
|  |                          |  |   |
| <b>121101</b>   | Teleskop Aluminium skaft |  |   |
|  |                          |  |   |







|   |                                |            |   |
|---|--------------------------------|------------|---|
| <b>715095.04</b>  | Handspännare & Band            | Dubbelkrok | 50mm  |
|    |                                |            | Spännare: 0,5m med dubbelkrok<br>Band: 9,5m med dubbelkrok  |
| <b>715094</b>   | Handspännare & Band            | E-fäste    |   |
|    |                                |            | För surring i combiskena<br> |
| <b>715196.1</b>   | LS HANDSPÄNNARE + LS BAND 0,3M |            |   |
|   |                                |            |   |
| <b>715180</b>   | EKERI-PIN (hundben)            |            |   |
|  |                                |            |   |



|                                      |  |        |             |                |      |
|--------------------------------------|--|--------|-------------|----------------|------|
| Dokumentnamn: Reservdelslista Övrigt |  |        |             | Rev 2025-02-20 |      |
| Framtagen av:                        | Fastställd av:                               | Utgåva | Gäller från | Område         | Sida |
| Rasmus Robertsson<br>Pls             | Roberto Montero<br>KMA Koordinator PLS Group | 1      | 2022-01-10  | 8.2            | 1    |

# Reservdelslista samling (Övrigt)

| Artikel nr.   | Benämning             | Beskrivning |   |
|---|-----------------------|-------------|---|
| 860225.1  | DÖRRHÅLLARE H         |             |   |
| 860225.2  | DÖRRHÅLLARE V         |             |   |
|    |                       |             | 8860225.10 Fäste<br>860225.21 Arm<br>860225.22 Tapp<br>860225.213 Spårryttare |
| 820420.01   | FOTSTEG PLS ZH        |             | VARMFÖRZINKAS   |
|    |                       |             | För montering i Zepro underkörningsskydd                                      |
| 820420.02   | FOTSTEG PLS ZV        |             | VARMFÖRZINKAS   |
|   |                       |             | För montering i Zepro underkörningsskydd                                      |
| 820423  | FOTSTEG Z-LYFT BOCKAD |             |   |
|  |                       |             |   |
| 717093.20   | Backstöd V, PU kort   |             |   |
|  |                       |             | Vid bakdörrar   |
| 717094.20   | Backstöd H, PU kort   |             |   |
|  |                       |             | Vid bakdörrar   |

|   |                      |         |   |
|---|----------------------|---------|---|
| <b>717000.200</b>   | GUMMIBACKSTÖD        |         | L=200mm   |
|    |                      |         | Vid Överlucka   |
| <b>859110</b>   | Vagnfäste Fjäder     |         | FÖR ÖBS 3+5 samt 5+5  |
|    |                      |         | Hängrulle ingår ej<br><br>860132 Platta<br>860133.21 Arm<br>860131.06 Fjäder x2 |
| <b>859111</b>   | Vagnfäste Fjäder     |         | FÖR ÖBS 3+5 samt 5+5  |
|   |                      |         | Hängrulle ingår ej<br><br>860132 Platta<br>860133.31 Arm<br>860131.06 Fjäder    |
| <b>859112</b>   | Vagnfäste Fjäder bil | Vänster | FÖR ÖBS 3+3 samt 3+5  |
| <b>859113</b>   | Vagnfäste Fjäder bil | Höger   | FÖR ÖBS 3+3 samt 3+5  |
|  |                      |         | Hängrulle ingår ej<br><br>860132 Platta<br>860133.21 Arm<br>860131.06 Fjäder    |
| <b>860130.01</b>  | Vagnfäste RFS        |         | FÖR ÖBS 3+3 H-V   |
|  |                      |         | Hängrulle ingår ej<br><br>716066 Platta<br>860172 Arm                           |
| <b>717150</b>   | HÄNGRULLE NYLON HD   |         |   |
|  |                      |         |   |